

## PROMOTIVNA AKCIJA - INOX

Poštovani kupci

Predstavljamo vam **PROMOTIVNU AKCIJU SETOVA ALATA ZA STRUGANJE** za obradu **INOXA**.

Promocija je napravljena na način da se kupovinom **40 kom pločica za struganje** po promotivnoj akciji osigurava pravo na **BESPLATAN PRIHVAT ALATA**.

**Akcija Traje od 15.03.2021 - 15.06.2021**

**40 kom**

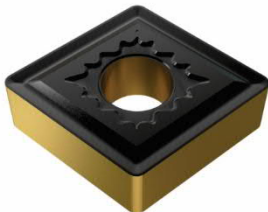

**+**

**DRŽAČ GRARTIS**



## PROMOTIVNA AKCIJA ALATA ZA STRUGANJE «INOX» «40 PLOČICA + PRIHVAT GRATIS»

### SETOVI ZA VANJSKO STRUGANJE

**40 Kom**

Pločica  
WNMG 080412-MR YG3030



INOX , Normalna - Srednje Gruba Obr.

+

**1 Kom**

Držač Pločice (Desni)  
PCLNR 2525M12C

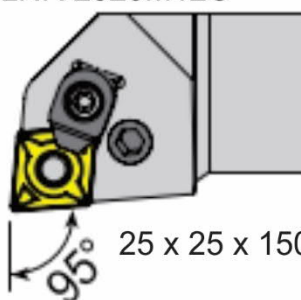

=

**284 KM**

Cijena Seta  
40 + 1

**40 Kom**

Pločica  
CNMG120408- MM YG3030



INOX , Normalna Stabilna Obrada

+

**1 Kom**

Držač Pločice (Desni)  
PCLNR 2525M12C

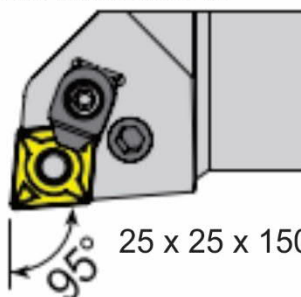

=

**284 KM**

Cijena Seta  
40 + 1

**40 Kom**

Pločica  
CNMG120408- MM YG3030



INOX , Normalna Stabilna Obrada

+

**1 Kom**

Držač Pločice (Desni)  
PCLNR 2020K12C

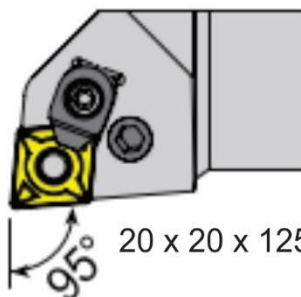

=

**284 KM**

Cijena Seta  
40 + 1

**PROMOTIVNA AKCIJA ALATA ZA STRUGANJE «INOX»**  
**«40 PLOČICA + PRIHVAT GRATIS»**

**40 Kom**

Pločica  
CNMG120408- MM YG3030

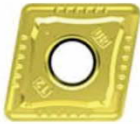

INOX , Normalna Stabilna Obrada

+

**1 Kom**

Držač Pločice (Desni)  
PCLNR 2020K12C

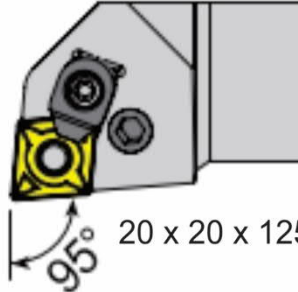

=

**284 KM**  
Cijena Seta  
40 + 1

**40 Kom**

Pločica  
WNMG 060404-MF YG3010



INOX , Srednje Gruba Obrada

+

**1 Kom**

Držač Pločice (Desni)  
S20R MWLNR 06

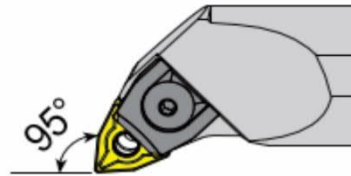

=

**268 KM**  
Cijena Seta  
40 + 1

**40 Kom**

Pločica  
CCMT 09T308-UG YG3030



INOX , CELIK ; Normalna Stabilna Obr

+

**1 Kom**

Držač Pločice (Desni)  
SCLCR 2525M12

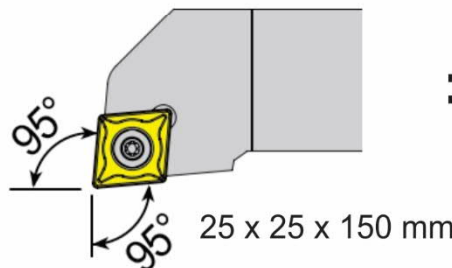

=

**244 KM**  
Cijena Seta  
40 + 1

## PROMOTIVNA AKCIJA ALATA ZA STRUGANJE «INOX» «40 PLOČICA + PRIHVAT GRATIS»

### 40 Kom

Pločica  
CCMT 09T304-UF YG3010



INOX ; CELIK , Fina Obrada

### 1 Kom

Držač Pločice (Desni)  
SCLCR 2020K09

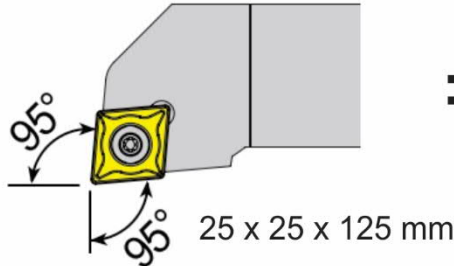

**244 KM**  
Cijena Seta  
40 + 1

### 40 Kom

Pločica  
DNMG 150612 – MM YG211



INOX , Normalna Stabilna Obrada

### 1 Kom

Držač Pločice (Desni)  
PDJNR2525M15C

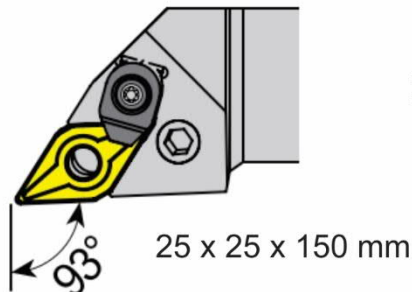

**378 KM**  
Cijena Seta  
40 + 1

## PROMOTIVNA AKCIJA ALATA ZA STRUGANJE «INOX» «40 PLOČICA + PRIHVAT GRATIS»

### 40 Kom

Pločica  
DNMG 150604 – MF YG211



INOX , Fina Obrada

+

### 1 Kom

Držač Pločice (Desni)  
PDJNR2525M15C

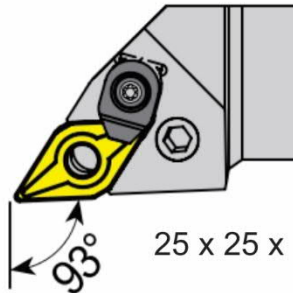

=

**378 KM**

Cijena Seta  
40 + 1

### 40 Kom

Pločica  
DNMG 150608– MM YG211



INOX , Normalna Stabilna Obrada

+

### 1 Kom

Držač Pločice (Desni)  
PDJNR2020K15C

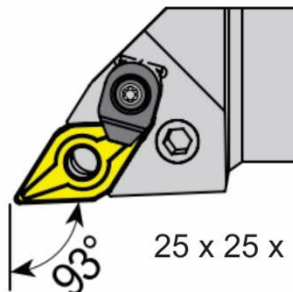

=

**378 KM**

Cijena Seta  
40 + 1

### 40 Kom

Pločica  
WNMG 080412-UC YG3020



INOX , Srednje Gruba - Gruba Obrada

+

### 1 Kom

Držač Pločice (Desni)  
PWLNR2525M08C

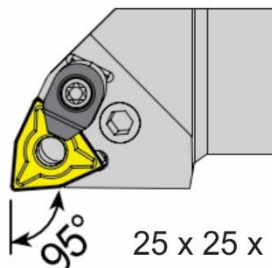

=

**284 KM**

Cijena Seta  
40 + 1

## PROMOTIVNA AKCIJA ALATA ZA STRUGANJE «INOX» «40 PLOČICA + PRIHVAT GRATIS»

### 40 Kom

Pločica

WNMG 080412-MM YG3030



+

### 1 Kom

Držač Pločice (Desni)

PWLNR2525M08C

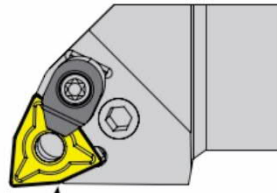

=

INOX , Normalna - Nestabilna Obrada

95° 25 x 25 x 150 mm

**284 KM**

Cijena Seta  
40 + 1

### 40 Kom

Pločica

WNMG 080412-MM Yg3020



+

### 1 Kom

Držač Pločice (Desni)

PWLNR2525M08C

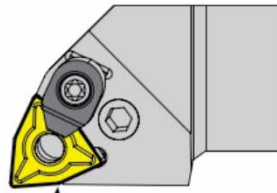

=

INOX , Normalna - Stabilna Obrada

95° 25 x 25 x 150 mm

**284 KM**

Cijena Seta  
40 + 1

### 40 Kom

Pločica

WNMG 060404-MF YG3010



+

### 1 Kom

Držač Pločice (Desni)

PWLNR2525M06

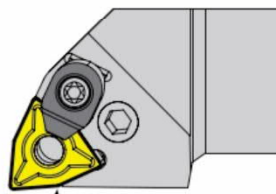

=

INOX , Fina Obrada

95° 25 x 25 x 150 mm

**244 KM**

Cijena Seta  
40 + 1

## PROMOTIVNA AKCIJA ALATA ZA STRUGANJE «INOX» «40 PLOČICA + PRIHVAT GRATIS»

### SETOVI ZA UNUTARNJE STRUGANJE

**40 Kom**

Pločica  
CNMG120404 – MM YG211



INOX , Normalna - Stabilna Obrada

+

**1 Kom**

Držač Pločice (Desni)  
S32T PCLCR 12C

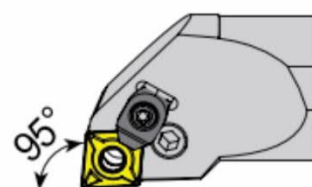

fi 32 x 300 mm

=

**314 KM**

Cijena Seta  
40 + 1

**40 Kom**

Pločica  
CNMG120412 – MR YG3030



INOX , Normalna - Gruba + Prekidni Rez

+

**1 Kom**

Držač Pločice (Desni)  
S32T PCLCR 12C

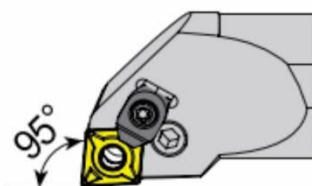

fi 32 x 300 mm

=

**314 KM**

Cijena Seta  
40 + 1

**40 Kom**

Pločica  
CNMG120408– MM YG3030



INOX , Normalna - Stabilna Obrada

+

**1 Kom**

Držač Pločice (Desni)  
S32T PCLCR 12C

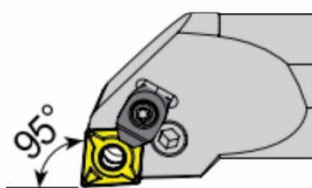

fi 32 x 300 mm

=

**314 KM**

Cijena Seta  
40 + 1

## PROMOTIVNA AKCIJA ALATA ZA STRUGANJE «INOX» «40 PLOČICA + PRIHVAT GRATIS»

### 40 Kom

Pločica  
DNMG 150612 – MM YG3030



+

### 1 Kom

Držać Pločice (Desni)  
S32T PDUNR 15

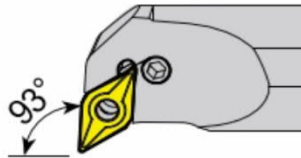

=

INOX , Normalna - Nestabilni Uslovi Rada

fl 32 x 300 mm

**416 KM**

Cijena Seta  
40 + 1

### 40 Kom

Pločica  
DNMG 150612 – MM YG3030



+

### 1 Kom

Držać Pločice (Desni)  
S25S PDUNR 15

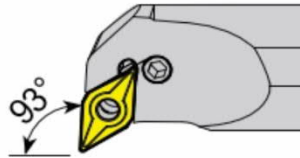

=

INOX , Normalna - Nestabilni Uslovi Rada

fl 25 x 250 mm

**400 KM**

Cijena Seta  
40 + 1

### 40 Kom

Pločica  
TNMG 160412 –MM YG213



+

### 1 Kom

Držać Pločice (Desni)  
S32T PTUNR 22C

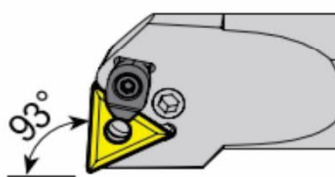

=

INOX , Srednje Gruba do Gruba Obrada

fl 32 x 300 mm

**360 KM**

Cijena Seta  
40 + 1



**PROMOTIVNA AKCIJA ALATA ZA STRUGANJE «INOX»  
«40 PLOČICA + PRIHVAT GRATIS»**

**40 Kom**

Pločica  
TNMG 160412 –MM YG213



INOX , Normalna Nestabilna Obrada

+

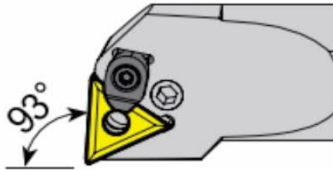

fl 25 x 250 mm

=

**292 KM**  
Cijena Seta  
40 + 1

**40 Kom**

Pločica  
TNMG 160408 –MF YG211



INOX , Fina Obrada

+

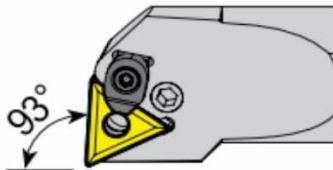

fl 20 x 200 mm

=

**275 KM**  
Cijena Seta  
40 + 1

**40 Kom**

Pločica  
WNMG 080412-MR YG3030



INOX , Srednje Gruba Obrada

+

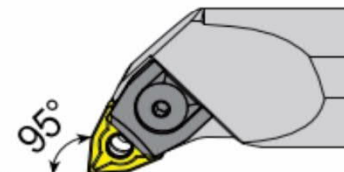

fl 25 x 250 mm

=

**300 KM**  
Cijena Seta  
40 + 1

## PROMOTIVNA AKCIJA ALATA ZA STRUGANJE «INOX» «40 PLOČICA + PRIHVAT GRATIS»

**40 Kom**

Pločica  
WNMG 060404-MF YG3010



INOX , Fina Obrada

+

**1 Kom**

Držać Pločice (Desni)  
S20R MWLNR 06

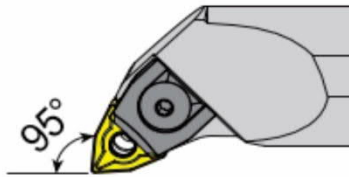

fl 32 x 200 mm

=

**268 KM**

Cijena Seta  
40 + 1

**40 Kom**

Pločica  
WNMG 080412-MM Yg3020



INOX , Normalna Stabilna Obrada

+

**1 Kom**

Držać Pločice (Desni)  
S16P MWLNR 06

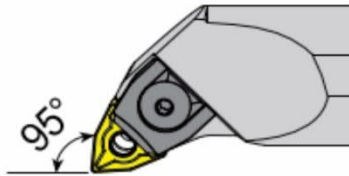

fl 32 x 170 mm

=

**266 KM**

Cijena Seta  
40 + 1