

ANALOGNA Pomična Mjerila

Werkstattmessschieber ohne Messerspitzen ohne Feineinstellung

- DIN 862
- Feststellschraube
- Lochmaßansatz:
- 0 - 300 mm = 10 mm
- 500 - 1000 mm = 20 mm
- rostfreier Stahl
- Nonius + Skala mattverchromt
- inkl. Etui



Vernier caliper without knife-edge without fine adjustment

- DIN 862
- lock screw
- ribs for inside measuring:
- 0 - 300 mm = 10 mm
- 500 - 1000 mm = 20 mm
- stainless steel
- scale and vernier satin chromed
- incl. box



110-22

> mm < Messbereich
Ablesung Range
Schnabellänge Reading
Length of jaws

> mm <	 mm	 inch	 mm	No.
300	0,05	1/128	90	110-22
500	0,05	1/128	150	110-34
800	0,05	1/128	150	110-36
1000	0,05	1/128	150	110-37
1500	0,05	1/128	200	113-14

Werkstattmessschieber mit Messerspitzen ohne Feineinstellung

- DIN 862
- Feststellschraube
- Lochmaßansatz:
- 0 - 300 mm = 10 mm
- 500 - 1000 mm = 20 mm
- rostfreier Stahl
- Nonius + Skala mattverchromt
- inkl. Etui

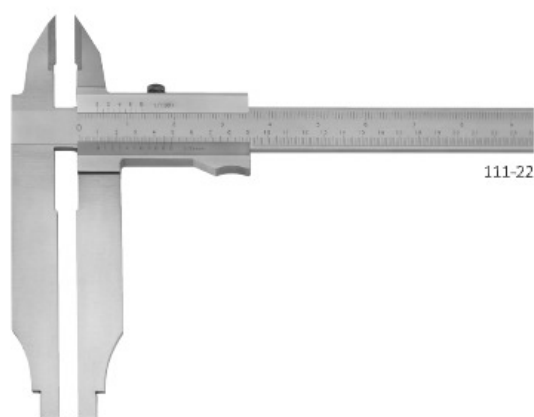

Vernier caliper with knife-edge without fine adjustment

- DIN 862
- lock screw
- ribs for inside measuring:
- 0 - 300 mm = 10 mm
- 500 - 1000 mm = 20 mm
- stainless steel
- scale and vernier satin chromed
- incl. box



111-22

> mm < Messbereich
Ablesung Range
Schnabellänge Reading
Length of jaws

> mm <	 mm	 inch	 mm	No.
300	0,05	1/128	90	111-22
500	0,05	1/128	150	111-34
800	0,05	1/128	150	111-36
1000	0,05	1/128	150	111-37

Ihr Partner für Handmessmittel



Messschieber mit Feststellschraube

- DIN 862
- rostfreier Stahl
- Ableseteile mattverchromt
- Vierfachmessung mit Gewindetabelle
- Inkl. Etui

Vernier pocket caliper with locking screw

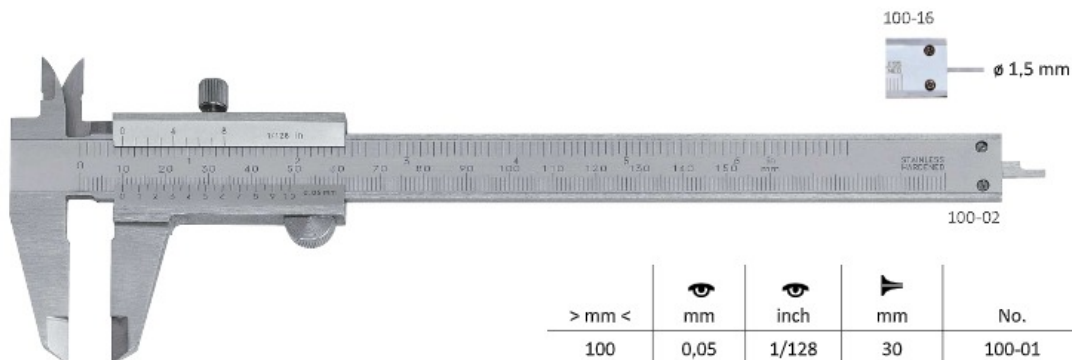
- *DIN 862*
- *stainless steel*
- *satin chromed reading parts*
- *quadruple measurements with thread table*
- *incl. box*



> mm <	 mm	 inch	 mm	No.
100	0,05	1/128	30	100-01
150	0,05	1/128	40	100-02
200	0,05	1/128	50	100-03
300	0,05	1/128	60	100-04
150	0,05	1/128	40	100-16



Messschieber mit Momentverstellung

- DIN 862
- rostfreier Stahl
- Ableseteile mattverchromt
- Vierfachmessung mit Gewindetabelle
- Inkl. Etui

Vernier pocket caliper with moment adjustment

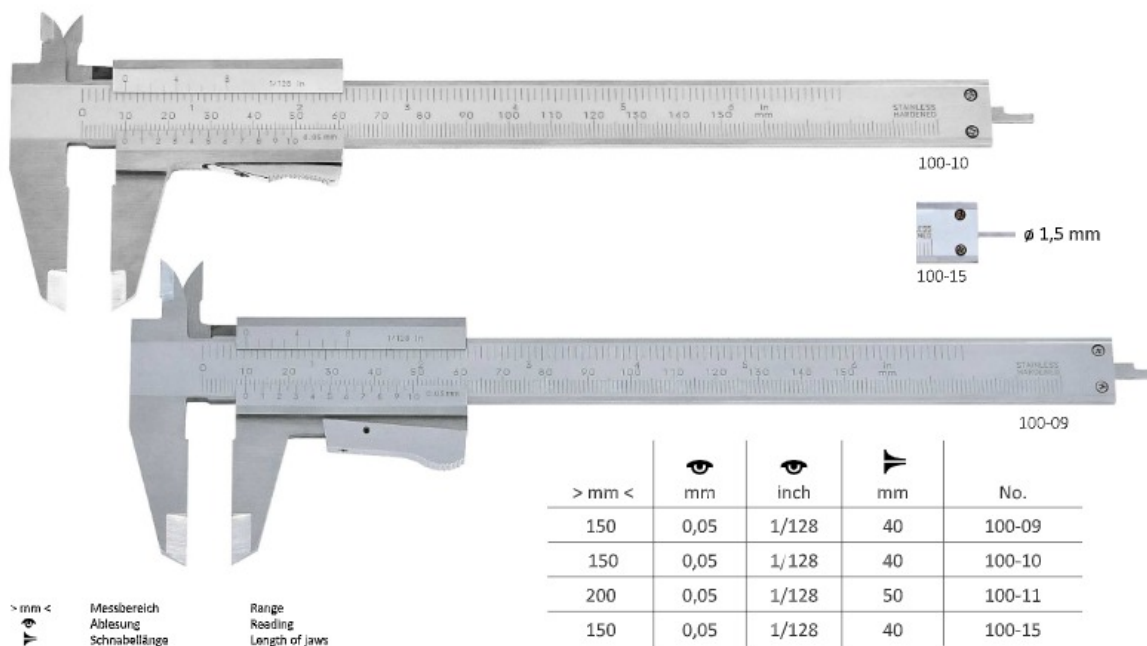
- *DIN 862*
- *stainless steel*
- *satin chromed reading parts*
- *quadruple measurements with thread table*
- *incl. box*



> mm <	 mm	 inch	 mm	No.
150	0,05	1/128	40	100-09
150	0,05	1/128	40	100-10
200	0,05	1/128	50	100-11
150	0,05	1/128	40	100-15

> mm < Messbereich Range
 Ablesung Reading
 Schnabellänge Length of jaws

Ihr Partner für Handmessmittel

Messzeug-Satz 3-teilig

im Kunststoff-Koffer, bestehend aus:

- Messschieber 150 mm
- Bügelmessschraube 0 - 25 mm
- Haarwinkel 100 x 70 mm

Toolmaker instrument set 3 pieces

in plastic case, consisting of:

- vernier caliper 150 mm
- outside micrometer 0 - 25 mm
- precision square 100 x 70 mm



No.
200-27

Messzeug-Satz 7-teilig

im Kunststoff-Koffer, bestehend aus:

- Messschieber 150 mm
- Bügelmessschraube 0 - 25 mm
- Haarwinkel 100 x 70 mm
- Haarlineal 100 mm
- Federzirkel 100 mm
- biegsamer Stahlmaßstab 200 mm, rostfrei
- Reißnadel 150 mm

Toolmaker instrument set 7 pieces

in plastic case, consisting of:

- vernier caliper 150 mm
- outside micrometer 0 - 25 mm
- precision square 100 x 70 mm
- straight edge 100 mm
- spring dividers 100 mm
- flexible graduated metal rule 200 mm, stainless
- scriber 150 mm



No.
200-26