

DIGITALNA Pomíčna Mjerila

Messschieber aus Aluminium



- extrem leicht (0 - 500 mm: 680 g)
- zwei bewegliche Messschenkel
- Messschnäbel aus beschichtetem Aluminium
- Auflösung 0,1 mm/0,01 inch
- großes 14 mm Display
- Auto on/off
- mit Feststellschrauben
- Batterie SR44

Aluminum caliper

- Lightweight (0 - 500 mm: 680 g)
- Two movable measuring arms
- Measuring jaws in coated aluminum
- Resolution 0,1 mm/0,01 inch
- Large 14 mm display
- Auto on/off
- With locking screws
- Battery SR44



Funktionen: Ein/Aus, Null, mm/inch
Features: on/off, zero, mm/inch

> mm <				No.
500	0,1	0,01	150	2000-071
800	0,1	0,01	150	2000-072
1000	0,1	0,01	150	2000-073
1500	0,1	0,01	150	2000-074

Messschieber digital

leichte Ausführung aus Aluminium

- mit verstellbaren und auswechselbaren Messschnäbeln
- Messschnäbel aus rostfreiem, gehärtetem Stahl, fein geschliffen
- optimale Führungs- und Gleiteigenschaften durch innenliegende, doppelte Prismenführung
- Auto on/off
- Gleitschiene aus Aluminium, Oxyd beschichtet
- inkl. Etui und Batterie SR44

Digital caliper

light-weight type made of aluminum

- with adjustable and changeable jaws
- jaws made of stainless, hardened and ground steel
- optimal guidance and sliding characteristics due to inner double prismatic guide
- Auto on/off
- slide bar made of aluminum, oxid coated
- incl. box and battery SR44







LIGHT-LINE

Funktionen: Ein/Aus, Null, mm/inch
Features: on/off, zero, mm/inch

> mm <  Messbereich
 Ablesung
 Genauigkeit
 Schnabellänge

Range
 Reading
 Accuracy
 Length of jaws

> mm <					No.
300	0,01	0,0005	0,04	90	2000-020
500	0,01	0,0005	0,05	90	2000-021
800	0,01	0,0005	0,06	90	2000-022

Ihr Partner für Handmessmittel

Messschieber für Außennuten

- DIN 862
- Auflösung 0,01 mm/0,0005 inch
- Auto on/off
- mit Feststellschraube
- Batterie CR2032
- inkl. Etui

Messflächen
 • 1,0 mm dick, 5,0 mm tief

Caliper for outside grooves

- DIN 862
- Resolution 0,01 mm/0,0005 inch
- Auto on/off
- With locking screw
- Battery CR2032
- in case

Measuring faces
 • 1,0 mm thick/5,0 mm deep

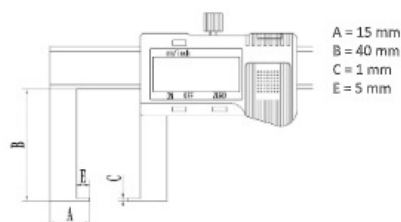

A = 15 mm
 B = 40 mm
 C = 1 mm
 E = 5 mm

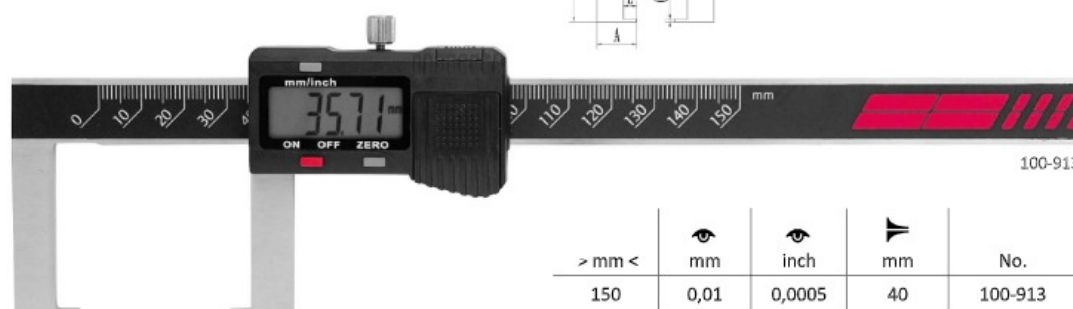

100-913

> mm <	mm	inch	mm	No.
150	0,01	0,0005	40	100-913

Messschieber für Innennuten

- DIN 862
- Auflösung 0,01 mm/0,0005 inch
- Auto on/off
- mit Feststellschraube
- Batterie CR2032

Messflächen
 • 1,0 mm dick, 5,0 mm tief (100-911)
 • 1,5 mm dick, 6,0 mm tief (100-912)

Caliper for inside grooves

- DIN 862
- Resolution 0,01 mm/0,0005 inch
- Auto on/off
- With locking screw
- Battery CR2032

Measuring faces
 • 1,0 mm thick, 5,0 mm deep (100-911)
 • 1,5 mm thick, 6,0 mm deep (100-912)

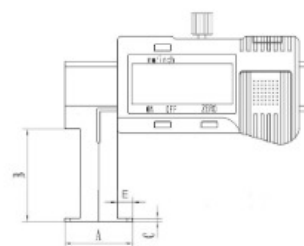

	100-911	100-912
A =	22 mm	35 mm
B =	30 mm	60 mm
C =	1,0 mm	1,5 mm
E =	5 mm	6 mm

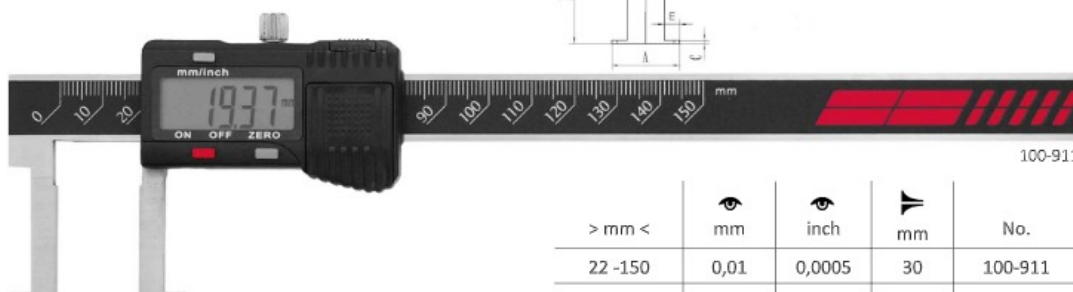

100-911

> mm <	mm	inch	mm	No.
22 - 150	0,01	0,0005	30	100-911
35 - 200	0,01	0,0005	60	100-912

> mm < Messbereich Range
 Ablesung Reading
 Schnabellänge Length of jaws

32 Gesamtkatalog 2019/2020

HITEC Messtechnik GmbH

Nuten-Messeinsätze für Taschenmessschieber

- Für Messschieber 150mm, 200mm, 300mm digital
- Zum Messen von Innen- und Außennuten, O-Ring und Hinterstichen, in Verbindung mit Messschiebern mit max. 3,5 mm Messschenkelstärke

Grove measurement caliper jaws

- Fits on any digital 150mm, 200mm, 300mm caliper
- Enables the measurement of hard to reach work piece characteristics such as interna grooves till 3,5mm

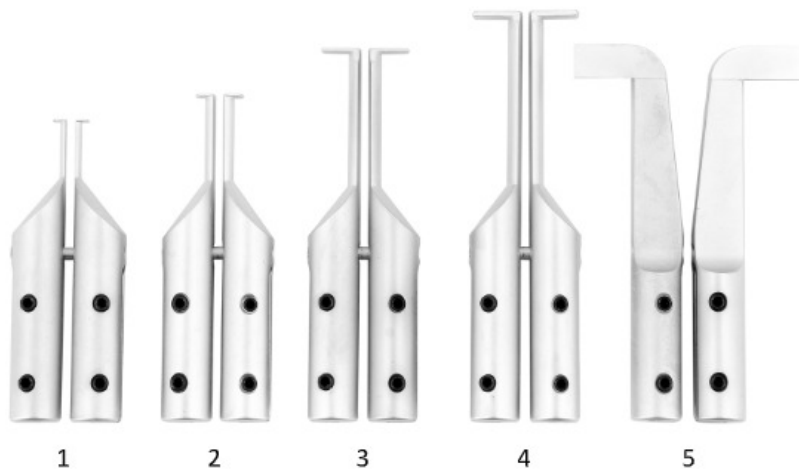

120-68

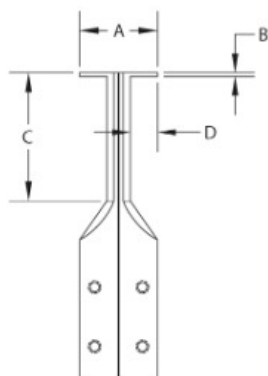

	A (mm)	B (mm)	C (mm)	D (mm)	No.
1	5	0,4	10	1,3	120-68
2	7,5	0,4	16	1,75	
3	15	0,65	25	5	
4	18	1,0	32	6,5	
5	Außen/external	0,65	40	9,5	

Ihr Partner für Handmessmittel

Messzeug-Satz 3-teilig

im Kunststoff-Koffer, bestehend aus:

- Messschieber 150 mm
- Bügelmessschraube 0 - 25 mm
- Haarwinkel 100 x 70 mm

Toolmaker instrument set 3 pieces

in plastic case, consisting of:

- vernier caliper 150 mm
- outside micrometer 0 - 25 mm
- precision square 100 x 70 mm



No.
200-27

Messzeug-Satz 7-teilig

im Kunststoff-Koffer, bestehend aus:

- Messschieber 150 mm
- Bügelmessschraube 0 - 25 mm
- Haarwinkel 100 x 70 mm
- Haarlineal 100 mm
- Federzirkel 100 mm
- biegsamer Stahlmaßstab 200 mm, rostfrei
- Reißnadel 150 mm

Toolmaker instrument set 7 pieces

in plastic case, consisting of:

- vernier caliper 150 mm
- outside micrometer 0 - 25 mm
- precision square 100 x 70 mm
- straight edge 100 mm
- spring dividers 100 mm
- flexible graduated metal rule 200 mm, stainless
- scriber 150 mm



No.
200-26