

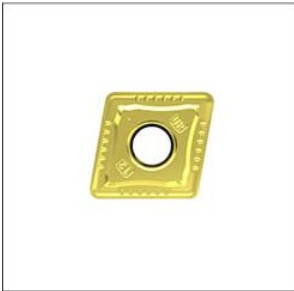





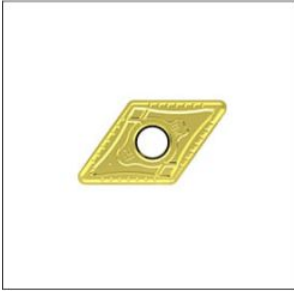

Košarica

[Vidi košaricu](#) "Pločica za Struganje DCMT 11T304-UF YG3010 (Čelik + Sivi Liv – Fina Obrada) 22000213" je dodano u vašu košaricu.

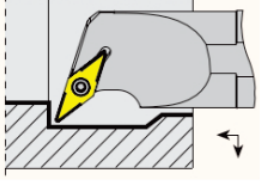
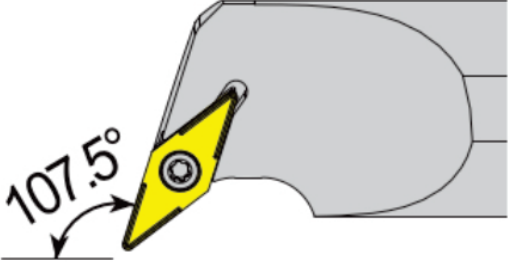
		Proizvod	Cijena	Količina	Ukupno
x		Pločica za Struganje DCMT 11T304-UF YG3010 (Čelik + Sivi Liv - Fina Obrada) 22000213	7.00KM 6.37KM	Količina - 1 +	6.37KM
x		Pločica za Struganje CNMG 120404-UF YG3020 (Čelik - Fina Obrada) 22000179	7.57KM 6.89KM	Količina - 1 +	6.89KM
x		Pločica za Struganje WNMG 080412-MM YG211 (Inox - Normal Nestabilna Obrada) 22000612	7.60KM 6.92KM	Količina - 1 +	6.92KM

		Proizvod	Cijena	Količina	Ukupno
x		Pločica za Struganje DNMG 150608-UR YG3010 (Čelik, Sivi Liv - Gruba+Prekinut Rez) 22000692	10.05KM 9.15KM	<input type="text" value="1"/> <input type="button" value="-"/> <input type="button" value="+"/> Količina	9.15KM
x	<p>DIN371/DIN376 UNF</p>  <p>TD874 DIN371/DIN374 Spiral Point TiN</p> <p>UNF DIN 371/374 Form B 60° 2B HSS-E TiN</p> <p>RH Thread</p>	Ravni UNF Ureznik #10 - 32 UNF (TD874342 - Combo Taps - TiN Pesvlaka)	29.70KM 24.95KM	<input type="text" value="1"/> <input type="button" value="-"/> <input type="button" value="+"/> Količina	24.95KM
x	  <p>107.5°</p> <p>SVQBR</p>	Prihvat za Unutarnje Struganje S32T-SVQBR 16 (VB1604) 27001307	95.90KM 79.60KM	<input type="text" value="1"/> <input type="button" value="-"/> <input type="button" value="+"/> Količina	79.60KM

		Proizvod	Cijena	Količina	Ukupno
x		Spiralni Metrički Fini Ureznik M30 x 2 (TD8448966- Combo Taps - TIN Presvlaka)	181.10KM 152.12KM	<input type="text" value="2"/> <input type="button" value="-"/> <input type="button" value="+"/>	304.24KM
x	<p>F - RDKT 12</p>  <p>(SHELL MILL)</p> <p>D80 Z7</p>	Glodački Prihvat F-RDKT12-D80Z7S27 (RDKT 1204) 17000586	222.40KM 184.59KM	<input type="text" value="1"/> <input type="button" value="-"/> <input type="button" value="+"/>	184.59KM

	Proizvod	Cijena	Količina	Ukupno
 <p>S16 - 3D 16.0 mm - 16.9 mm</p>	I-One Driil Nosač S16 -3D (Fi 16.0- Fi 16.9 mm) ZD16003020	294.50KM 265.05KM	<input type="button" value="-"/> Količina <input type="text" value="1"/> <input type="button" value="+"/>	265.05KM

Kupon Primjeni kupon
Ažuriraj košaricu

Sveukupno

Ukupno	887.76KM
Porez	150.92KM
Ukupno	1,038.68KM

[Kompletiraj narudžbu](#)

Sveukupno

Ukupno	887.76KM
Porez	150.92KM
Ukupno	1,038.68KM

[Kompletiraj narudžbu](#)